



Solutions for everyday living.

Philosophy

Welcome to the WOOZOO by Ohyama univers !

Woozoo brand is our home appliances and electricals range. Whether you're looking for fans, room air, kitchen appliances you can count on us to stick to our promise and deliver a product that you will love ! Iris Ohyama strives to provide solutions for every need, in every season. Our products are designed to offer the ideal comfort while respecting the environment. Our technologists guarantee efficiency, performance, ease of use and design.

Discover our **Iris Ohyama general catalog** dedicated to the Storage, Furniture, Pet, Garden & Others.

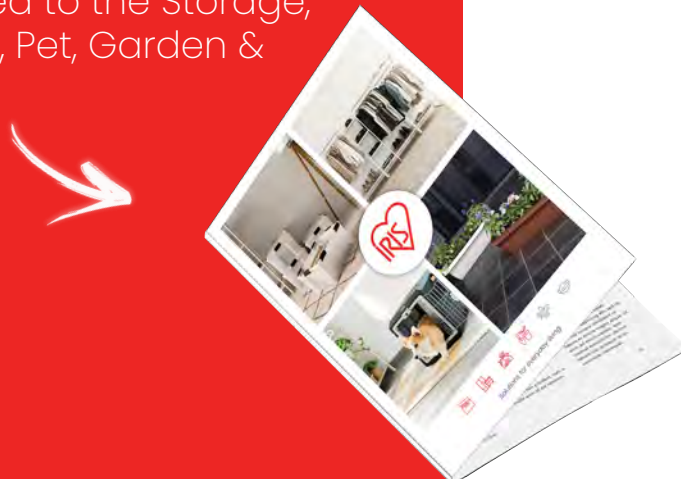

OUR WATCHWORDS

QUALITY & TRUST



Quality, performance and trust are at the centre of everything we do, which is why IRIS OHYAMA has become a globally recognised all over the world ! Our specialist team of buyers, technicians, manufactures and customer services ensure we are always best-in-class.

PERFORMANCE & DESIGN

Our industry-leading knowledge and experience in designing and manufacturing quality electricals products can guarantee that we will always fulfil our promise.



SERVICE



Day after day, Iris Ohyama earn the trust of millions of consumers and we intent to keep it that way. We aim to build relationships with our customers and being as transparent as possible helps us maintain this trust.

Follow us on our website
www.irisohyama.fr
and on our social media for
more inspiration and advises



A close-up photograph of a dark brown, circular fan grille. The grille is composed of numerous curved, overlapping blades that create a complex, web-like pattern. In the center of the grille is a circular hub with a slightly different texture. On this hub, the brand name "WOZZO" is printed in a white, sans-serif font, with a registered trademark symbol (®) to the right. Below the brand name, the text "by Ohyama" is printed in a smaller, white, sans-serif font.

WOZZO®
by Ohyama

IRIS OHYAMA GROUP



Iris Ohyama was established in 1958 and began as a small town factory for plastic molding in Higashi-Osaka, Japan. More than 50 years since we developed our first original plastic product, we have continued to manufacture and supply a variety of both household and industrial products, such as furniture, home appliances, and hygiene products across the globe.



Akihiro OHYAMA

CEO of Iris Ohyama Group

Kentaro OHYAMA

Founder of Iris Ohyama Group



Provide «Solutions» across the world through a wide range of business development.



Iris Ohyama developed the world's first transparent plastic storage product. It influenced a change in the storage culture of the world.

More than sixty years of solutions for everyday life

Worldwide Solutions

Since the 1990s, IRIS has expanded to China, United States, South Korea, and Europe. We now have more than 35 production and distribution facilities across 6 countries, manufacturing and selling locally for local consumption.

In 1998, IRIS expanded business to Europe by establishing a production factory in the Netherlands. Today, in addition to manufacturing plastic products, we are expanding our business by importing and selling furniture and home appliances.

In 2019, IRIS established the second European factory in France. In addition to plastic products, we have begun local production of sanitary masks and circulator fans to further strengthen our production and distribution within the European market.

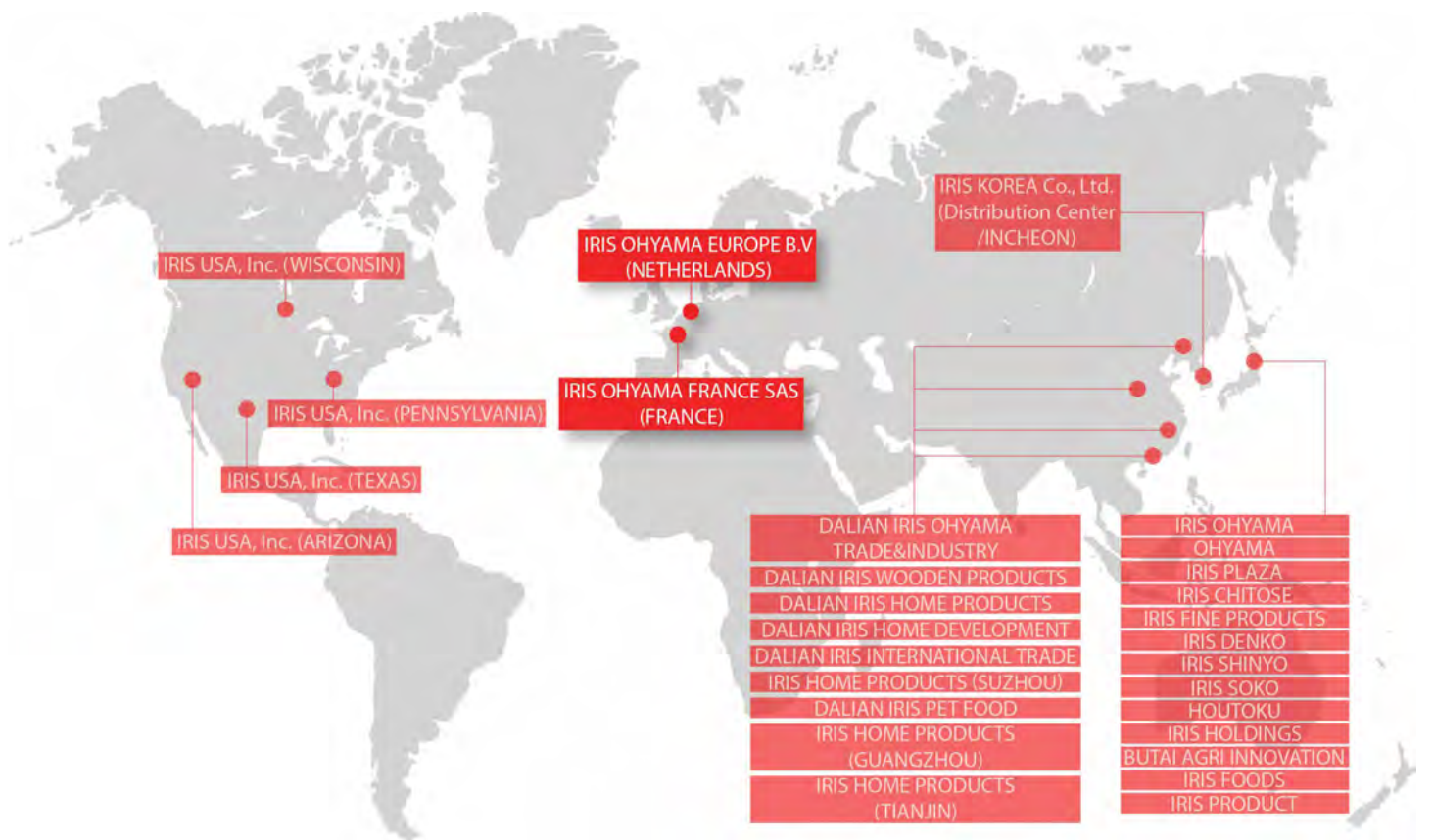

Through 35 manufacturing and distribution sites with more than 15,000 employees across the globe, we have created a global supply network.



We carry more than 25,000 products and develop over 1,000 new products every year.

SUMMARY



CIRCULATOR

P.08



ROOM AIR

P.28

Circulator

Circulator PCF-HD18	12
Circulator PCF-M15	13
Circulator PCF-M18	13
Circulator PCF-SM12	14
Circulator PCF-SM12N	14
Circulator PCF-HE15	16
Circulator PCF-HE18	16
Circulator PCF-MKM18	18
Circulator PCF-MKC18	18
Circulator PCF-SC15T	20
Circulator PCF-SDC15T	22
Circulator PCF-SDC18T	22
Circulator STF-DC15T	24
Circulator STF-DC18T	24

Room Air

Tower Fan TWF-C82T	30
Portable Air Conditioner IPE-1221G & IPE-1221GH	32
Portable Air Conditioner IHP-0901G-E	34
Air Purifier with Monitor AP45-M	35
Replacement HEPA Filter AP45-HEPA	35
Replacement Carbon Filter AP45-CARB	35
Dehumidifier with Circulator DDC-50	36
Ceramic Fan Heater JCH-15TD4	37



CLEANING

P.38

Cleaning

Cordless Vacuum Cleaner SCD-130P	40
Exhaust filter CFT102	40
Floor Mop with Vibration IC-M01-W	41
Soft Pad for Floor Mop MC-S01	41
Scrub Pad for Floor Mop MC-P01	41
Handy Cleaner IC-H50	42
Filter 2pcs set CS-FS2	42
Quilt Cleaner IC-FAC2	44
Quilt Cleaner IC-FAC4	44
2 Dust Filter CF-FS2	45
2 Exhaust Filter CF-FH2 for IC-FAC2	45
2 Exhaust Filter CF-FH3 for IC-FAC4	45
25 Disposable Filter CF-FTI for IC-FAC4	45



**WARMER &
DRYER**

P.46



COOKING

P.52

Warmer & Dryer

Bed Warmer BW-C1	48
Deodorizing Shoe Dryer KSD-C1	49
Quilt Dryer FK-C2	50
Quilt Dryer Twin Nozzle FK-W1	51

Cooking

Multi Cooker PC-MA3	54
IH rice cooker RC-ID31	55



OTHERS

P.56

Others

Heated Vest Men HW-01M & Women HW-01W	58
Ceiling Light Dim	60
Ceiling Light Dim&Ton	60
Dry Cell Battery LR6/AA	62
Dry Cell Battery LR03/AAA	62

CIRCULATOR



CIRCULATOR



Why choose WOOZOO?



WOOZOO circulators sales surpass 14 million units worldwide*
 The name «WOOZOO» comes from a Japanese word for spiral.
 Our circulators offer powerful spiral airflow throughout the whole room.
 Compact yet powerful.

3D BLADES DESIGN

The blades of WOOZOO are deeper than most conventional fans. Deep-pitch blades create more powerful wind streams, ensuring better air distribution while reducing the noise.

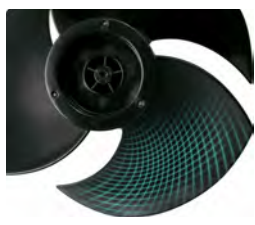

TRADITIONAL FANS VS CIRCULATORS

A traditional fan has a wider dispersion of air. It brings cooling benefits only when the airflow direction is towards you. On the contrary, a WOOZOO circulator keeps the air in a room moving and delivers comfort evenly anywhere in the room for a more comfortable environment wherever you are.



SPIRAL AIRFLOW

The rounded body and the spiral grill gather the air in the centre, increasing the airflow speed, and send the powerful wind stream further.



FOR ALL-YEAR-ROUND

Did you know that circulators are made to use both in summer and winter? When you use heaters in winter, the warm air naturally rises to the ceiling. By positioning the circulator upwards, it will help circulate warm air throughout the room.



WHISPER QUIET

WOOZOO circulators are powerful yet silent. Various fan speed levels are available and at low level, it's quiet like a whisper.



EFFICIENT VENTILATION

Improving indoor ventilation helps to reduce the risk of the virus spreading indoors. Positioning a circulator facing an open window can efficiently move the air from inside to outside.

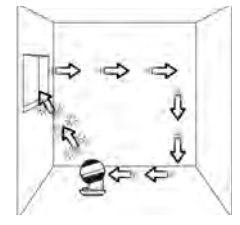

ZOO[®]

by Ohyama



Main features introduction

MULTI DIRECTIONAL OSCILLATION

Provides horizontal and vertical airflow simultaneously to send the air widely.



POWERFUL AIR CIRCULATION MODE

Quickly and efficiently circulates the air throughout the room at max fan speed.



NATURAL BREEZE

Replicates breeze patterns by changing the strength of the air flow. The airflow level changes automatically like a natural breeze.

*More comfortable than fixed airflow level
Suitable for sleep*



DC MOTOR

Optimises performance and reduces energy consumption.



NIGHT MODE

Adapts the airflow volume to ensure comfortable sleep. Strong airflow upwards and lighter airflow downwards.



LIGHT WEIGHT & PORTABLE

To easily move your Woozoo circulator from one room to another.





Circulator PCF-HD18



+

↔ Oscillation

↕ Vertical tilt

👉 Transport handle



Functions

- Speed setting : 3
- Horizontal oscillation : 80° (auto)
- Vertical oscillation : 110° (manual) – 6 positions

Specifications

- Rated power : 34 W
- Rated voltage : 220-240V ~
- Rated frequency : 50Hz
- Product dimensions (WxDxH) : 29 x 19 x 31,5 cm
- Product weight : 2 kg



Circulator PCF-M15

Circulator PCF-M18



Compact yet powerful



Easy to use



Functions

- Speed setting : 3
- Horizontal oscillation : 80° (auto)
- Vertical oscillation : 75° (manual) – 5 positions

Specifications

- Rated power : 32 W
- Rated voltage : 220-240V ~
- Rated frequency : 50Hz
- Product dimensions (WxDxH) : 22 x 20,3 x 30,3 cm
- Product weight : 2 kg

Functions

- Speed setting : 3
- Horizontal oscillation : 80° (auto)
- Vertical oscillation : 75° (manual) – 6 positions

Specifications

- Rated power : 33 W
- Rated voltage : 220-240V ~
- Rated frequency : 50Hz
- Product dimensions (WxDxH) : 25 x 22,8 x 33,5 cm
- Product weight : 2,4 kg



Circulator PCF-SM12

Circulator PCF-SM12N



Compact yet powerful



Easy to use

Functions

- Speed setting : 3
- Horizontal oscillation : 80° (auto)
- Vertical oscillation : 115° (manual) - 9 positions

Specifications

- Rated power : 20 W
- Rated voltage : 220-240V ~
- Rated frequency : 50Hz
- Product dimensions (WxDxH) : 18 x 18 x 25 cm
- Product weight : 1,3 kg

Functions

- Speed setting : 3
- Vertical oscillation : 115° (manual) - 9 positions

Specifications

- Rated power : 18 W
- Rated voltage : 220-240V ~
- Rated frequency : 50Hz
- Product dimensions (WxDxH) : 18 x 18 x 24 cm
- Product weight : 1,1 kg







Circulator PCF-HE15

Circulator PCF-HE18



+

 Lightweight

 360° vertical rotation

Functions

- Speed setting : 3
- Vertical oscillation : 360° (manual) – 20 positions

Specifications

- Rated power : 30 W
- Rated voltage : 220-240V ~
- Rated frequency : 50Hz
- Product dimensions (WxDxH) : 25,1 x 18,5 x 25,7 cm
- Product weight : 1 kg

Functions

- Speed setting : 3
- Vertical oscillation : 360° (manual) – 20 positions

Specifications

- Rated power : 31 W
- Rated voltage : 220-240V ~
- Rated frequency : 50Hz
- Product dimensions (WxDxH) : 28,2 x 21,6 x 28,7 cm
- Product weight : 1,4 kg





Circulator PCF-MKM18

Circulator PCF-MKC18



+

↔	Oscillation		Remote control*
↑↓	Vertical tilt		OFF timer*

Functions

- Speed setting : 3
- Horizontal oscillation : 65° (auto)
- Vertical oscillation : 110° (manual) - 6 positions

Specifications

- Rated power : 49 W
- Rated voltage : 220-240V ~
- Rated frequency : 50-60Hz
- Product dimensions (WxDxH) : 29,1 x 19,1 x 31 cm
- Product weight : 2,1 kg

Functions

- Speed setting : 3
- Horizontal oscillation : 65° (auto)
- Vertical oscillation : 110° (manual) - 6 positions
- OFF timer : 1/2/4 h
- Remote control

Specifications

- Rated power : 49 W
- Rated voltage : 220-240V ~
- Rated frequency : 50-60Hz
- Product dimensions (WxDxH) : 29,1 x 19,1 x 31 cm
- Product weight : 2,1 kg

*PCF-MKC18 only



CIRCULATOR





Circulator PCF-SC15T



+

-  Multi directional oscillation
-  Natural breeze
-  5 Fan speeds
-  Remote control
-  Off timer



Functions

- Speed setting : 5
- Horizontal oscillation : 80° (auto)
- Vertical oscillation : 75° (auto)
- Natural breeze : Yes
- OFF timer : 1/2/4 h
- Remote control

Specifications

- Rated power : 38 W
- Rated voltage : AC 220-240V ~
- Rated frequency : 50Hz
- Product dimensions (WxDxH) : 21 x 21 x 29 cm
- Product weight : 2 kg





Circulator PCF-SDC15T

Circulator PCF-SDC18T



+



10 Fan speeds



Powerful air circulation mode



Multi directional oscillation



DC motor



Remote control



On/Off timer

Functions

- Speed setting : 10
- Horizontal oscillation : 60°/90°/120° (auto)
- Vertical oscillation : 60° (auto)
- Natural breeze
- Air circulation
- ON timer : 2/4/8 h
- OFF timer : 2/4/8 h
- Remote control

Specifications

- Rated power : 25 W
- Rated voltage : DC24V
- Rated frequency : 50Hz
- Product dimensions (WxDxH) : 21 x 21 x 29 cm
- Product weight : 1,4 kg

Functions

- Speed setting : 10
- Horizontal oscillation : 60°/90°/120° (auto)
- Vertical oscillation : 60° (auto)
- Natural breeze
- Air circulation
- ON timer : 2/4/8 h
- OFF timer : 2/4/8 h
- Remote control

Specifications

- Rated power : 35 W
- Rated voltage : AC 220-240V ~
- Rated frequency : 50Hz
- Product dimensions (WxDxH) : 26 x 26 x 36,2 cm
- Product weight : 1,9 kg

MULTIDIRECTIONAL OSCILLATION

HORIZONTAL OSCILLATION
60° OR 90° OR 120°

VERTICAL OSCILLATION
0 TO 60°



The diagram illustrates the fan's oscillation features. It shows a top-down view of the fan with arrows indicating horizontal oscillation at 60, 90, and 120 degrees. A side view shows the fan tilting up and down, labeled as vertical oscillation from 0 to 60 degrees.

POWERFUL AND ECONOMICAL

DC JET MOTOR

Operates on direct current

ENERGY SAVINGS



The diagram shows a blue DC jet motor with a fan blade. A blue arrow points from the text 'Operates on direct current' to the motor, and another blue arrow points from 'ENERGY SAVINGS' to the motor.





Circulator STF-DC15T

Circulator STF-DC18T



BEST SELLER



STF-DC15T



STF-DC18T





+

 10 Fan speeds

 Multi directional oscillation

 DC motor

 Height adjustable

 Night mode

 On/Off timer

Functions

- Speed setting : 10
- Horizontal oscillation : 60°/90°/120° (auto)
- Vertical oscillation : 105° (auto)
- Natural breeze
- Night mode
- ON timer : 2/4/8 h
- OFF timer : 2/4/8 h
- Remote control

Specifications

- Rated power : 25 W
- Rated voltage : AC 220-240V ~
- Rated frequency : 50Hz
- Product dimensions (WxDxH) : 24 x 24 x 60 cm
- Product weight : 2,4 kg

Functions

- Speed setting : 10
- Horizontal oscillation : 60°/90°/120° (auto)
- Vertical oscillation : 105° (auto)
- Natural breeze
- Night mode
- ON timer : 2/4/8 h
- OFF timer : 2/4/8 h
- Remote control

Specifications

- Rated power : 35 W
- Rated voltage : AC 220-240V ~
- Rated frequency : 50Hz
- Product dimensions (WxDxH) : 27 x 27 x 64 cm
- Product weight : 2,7 kg



FEATURE COMPARISON



Model name		PCF-HD18	PCF-HE15	PCF-HE18	PCF-MKM18	PCF-MKC18	PCF-M15
Automatic oscillation	Left-Right	● 80°	●	●	● 65°	● 65°	● 80°
	Up-Down	●	●	●	●	●	●
	Multidirectional	●	●	●	●	●	●
Vertical tilt (Manual)		●	●	●	●	●	●
Speed setting		3	3	3	3	3	3
Natural breeze		●	●	●	●	●	●
Powerful air circulation		●	●	●	●	●	●
Night mode		●	●	●	●	●	●
ON timer		●	●	●	●	●	●
OFF timer		●	●	●	●	● 1/2/4 h	●
Remote control		●	●	●	●	●	●



PCF-M18	PCF-SM12N	PCF-SM12	PCF-SC15T	PCF-SDC15T	PCF-SDC18T	STF-DC15T	STF-DC18T
● 80°	●	● 80°	● 80°	● 60°/90°/120°	● 60°/90°/120°	● 60°/90°/120°	● 60°/90°/120°
●	●	●	● 75°	● 60°	● 60°	● 105°	● 105°
●	●	●	●	●	●	●	●
●	●	●	●	●	●	●	●
3	3	3	5	10	10	10	10
●	●	●	●	●	●	●	●
●	●	●	●	●	●	●	●
●	●	●	●	●	●	●	●
●	●	●	●	● 2/4/8 h	● 2/4/8 h	● 2/4/8 h	● 2/4/8 h
●	●	●	● 1/2/4 h	● 2/4/8 h	● 2/4/8 h	● 2/4/8 h	● 2/4/8 h
●	●	●	●	●	●	●	●





ROOM AIR



Tower Fan TWF-C82T



+

- ↔ Horizontal oscillation 45°
- ↕ Adjustable louvers 90°
- 🌀 Speed setting : 3
- 🍃 Natural breeze
- ⌚ OFF timer (1/2/4 Hours)
- 📶 Remote control

Functions

- Oscillation : 45° (auto)
- Adjustable louvers : 90° (manual)
- Speed setting : 3
- Natural breeze
- OFF timer : 1/2/4 h
- Remote control

Specifications

- Rated power : 42 W
- Rated voltage : 220-240V ~
- Product dimensions (WxDxH) : 26 x 26 x 79,3 cm
- Product weight : 3,6 kg









Portable Air Conditioner IPE-1221G & IPE-1221GH



+

 3 in 1 (Cooling/Dry/Fan)*

 4 in 1 (Cooling/Heating/Dry/Fan)**

 4 Fan speeds

 Sleep mode

 Remote control

 Child lock

 Washable filter

 360° gliding wheels

Capacity

- Coverage area : 16 - 23 m²
- Cooling capacity : 12000Btu/h (3520W)
- Heating capacity : 10500 Btu/h (3100 W)**
- Airflow volume (H/M/L) : 385/355/325 m³/h

Functions

- Cooling
- Heating**
- Dry
- Fan
- Speed setting : 4

- Sleep mode
- OFF timer : 0,5 - 24 h
- Child lock

Specifications

- Rated voltage : 220-240V ~
- Product dimensions (WxDxH) : 42,5 x 39,3 x 80,4 cm
- Product weight : 35 kg
- Refrigerant : R290
- Noise level (dB) : 62/63/64 dB
- Remote control
- Carrying handle
- Gliding wheels

*IPE-1221G only

**IPE-1221GH only













Portable Air Conditioner IHP-0901G-E



+

 3 in 1 (Cooling/Dry/Fan)	 Washable filter
 4 Fan speeds	 Auto clean
 Sleep mode	 360° gliding wheels
 Remote control	 Child lock



Capacity

- Coverage area : 10 - 16 m²
- Cooling capacity : 8870 Btu/h (2600 W)
- Airflow volume (H/M/L) : 260/290/320 m³/h

Functions

- Cooling
- Dry
- Fan
- Speed setting : 4
- Sleep mode

- OFF timer : 0,5 - 24 h
- Child lock

Specifications





- Rated voltage : 220-240V ~
- Product dimensions (WxDxH) : 35,5 x 46 x 86,6 cm
- Product weight : 27 kg
- Refrigerant : R290
- Noise level (dB) : 62/63/64 dB
- Remote control
- Gliding wheels



Air Purifier with Monitor AP45-M



+

-  Air quality indicator
-  3-Layer filter
-  3D Powerful suction
-  HEPA filter (remove 99.97% of particles)*



Capacity

- Coverage area : 41 m²
- CADR : 377 m³/h

Functions

- Speed setting : 5 (Silent/Medium/High/Turbo/Auto)

Specifications

- Rated power : 80 W
- Rated voltage : 220-240V ~
- Product dimensions (WxDxH) : 40 x 20,1 x 58,6 cm
- Product weight : 5,6 kg
- Filters : Pre-filter, Activated carbon filter, HEPA filter*

Replacement HEPA Filter AP45-HEPA

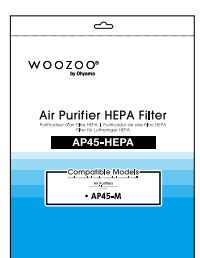

Replacement Carbon Filter AP45-CARB

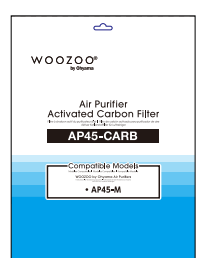

*HEPA filter removes particles as small as 0.3µm that pass through the filter.



Dehumidifier with Circulator DDC-50



+



With circulator



Drying capacity 4,5 L/day



Water tank capacity 2,5L

Oscillation 50°/
Adjustable tilt 90°

Auto shut-off



Capacity

- Drying capacity : 4,5 L/day
- Dehumidification coverage area : 21 m²
- Water tank capacity : 2,5 L

Functions

- Fan speed : 3
- OFF timer : 2/4/8 hours

- Oscillation (horizontal) : 50° (auto)
- Adjustable tilt (vertical) : 90° (manual)
- Automatic shut-off when tank is full

Specifications

- Rated power : 590 W
- Rated voltage : 220-240V ~
- Product dimensions (WxDxH) : 28,7 x 23,4 x 64 cm
- Product weight : 7,8 kg



Ceramic Fan Heater JCH-15TD4



+

- Motion sensor
- Fast heating
- Overheat / Tip-over shut-off
- Child lock



Functions

- Heating mode : High / Low
- Fan mode
- OFF timer : 1/2 hours
- Child lock

Specifications

- Rated power : 1500 W (High mode) / 750 W (Low mode)
- Rated voltage : 220-240V ~
- Product dimensions (WxDxH) : 26 x 13,5 x 38,5 cm
- Product weight : 2,5 kg









CHEATING



Cordless Vacuum Cleaner SCD-130P



+

-  Cyclone system
-  3-Step filtration
-  Dust sensor
-  Lithium ion battery (50 minutes runtime)
-  Flexible handle (180° left-right, 90° up-down)



Specifications (Main Unit)

- Vacuum pressure : 18,7 kPa
- Product dimensions (WxDxH) : 25,2 x 22 x 106 cm
- Product weight : 2,2 kg
- Including accessories : Charging adapter, crevice nozzle, 5 x exhaust filters

Specifications (Battery)

- Battery type : Lithium ion
- Voltage : 18,5 V
- Recharging time : 3,5 h
- Running time : 50 min

Exhaust filter CFT102 10 filters











Floor Mop with Vibration IC-M01-W



+

-  Vibration 900 times/minute
-  Water spray
-  Two types mop pads
-  Lithium ion battery (70 minutes runtime)
-  - LED headlight
-  Flexible handle (180°left-right, 90°up-down)



Capacity

- Water tank capacity : 90 ml

Specifications

- Battery type : Lithium ion
- Voltage : 11,1 V
- Recharging time : 5 h
- Running time : 70 min
- Product dimensions (WxDxH) : 26 x 26 x 115 cm
- Product weight : 2,3 kg
- Vibration speed : 900 times/minute

Including Accessories

- Charging adapter, measuring cup, soft pads, scrub pads, pin for cleaning the nozzle

Soft Pad for Floor Mop MC-S01



Scrub Pad for Floor Mop MC-P01







Handy Cleaner IC-H50





 Compact & Lightweight

 Lithium ion battery
(14 minutes runtime)



Specifications (Main Unit)

- Vacuum pressure : 13 kPa
- Filter type : HEPA Filter
- Product dimensions (WxDxH) : 56 x 57 x 40,2cm
- Product weight : 0,5kg
- Including accessories: Multi surface head, crevice and brush nozzle, charging base, charging adapter

Specifications (Battery)

- Battery type : Lithium Ion
- Voltage : 11,1 V
- Recharging time : 2,5 h
- Running time : 14 min

Filter 2pcs set CS-FS2







Quilt Cleaner IC-FAC2

Quilt Cleaner IC-FAC4



Cyclone stream :
98% house dust removal rate



Dust level indicator :
Shows cleaning progress at a glance



Agitator :
Taps at high speed and catches the house dust and mites hidden deep in the fabrics



Easy to clean :
Washable dust cup and mesh filter

Specifications

- Rated voltage : 220-240V ~
- Rated power : 400 W
- Product dimensions (WxDxH) : 25 x 14,4 x 40,3 cm
- Product weight : 1,6 kg
- Number of agitation : 6000/min
- Operation mode : 3 (High/Standard/Low)

Specifications

- Rated voltage : 220-240V ~
- Rated power : 600 W
- Product dimensions (WxDxH) : 30 x 16,7 x 42 cm
- Product weight : 2,2 kg
- Number of agitation : 14000/min
- Operation mode : 3 (High/Standard/Low)



2 Dust filters CF-FS2
.....



2 Exhaust filters CF-FH2 for IC-FAC2
.....



2 Exhaust filters CF-FH3 for IC-FAC4
.....



25 Disposable filters CF-FT1 for IC-FAC4
.....



WARMER & DRYER





WARMER & DRYER



WARMER & DRYER





Bed Warmer BW-C1



+

 Powerful heat (65° C)

 Extendable hose

 OFF timer

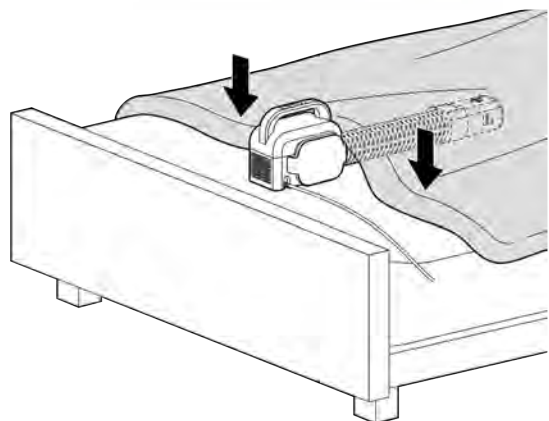

Functions

- Manual mode : 1 mode (High : 65° C)
- OFF timer : 10/20/30 min

Specifications

- Power : 490 W
- Product dimensions (WxDxH) : 37 x 15 x 18,4 cm
- Product weight : 1,8 kg
- Number of hose : 1





Deodorizing Shoe Dryer KSD-C1



+

-  Built-in deodorizer
-  Extendable hose
-  Suitable for all shoes (fabric, leather)
-  OFF timer



Functions

- 3 modes : High (50° C), Medium (40° C), Low (40° C)
- Deodorizing mode
- OFF timer : 30/60/120 min

Specifications

- Rated voltage : 220-240V ~
- Rated power : 230 W
- Product dimensions (WxDxH) : 13,7 x 10,1 x 28,9 cm
- Product weight : 770 g



Quilt Dryer FK-C2



+

- 4 preset modes (Winter, Summer, Warm, Dust mites)
- Powerful heat (65°)
- Extendable hose
- OFF timer
- Multi usage (Bed, Shoes)

Functions

- Preset Mode :
 - 4 modes : Winter (65° C for 60 min), Summer (65° C for 60 min), Warm Up (65° C for 20 min), Dust Mite (65° C for 100 min)
- Manual Mode :
 - 3 modes : High (65° C), Low (50° C), Fan
- OFF timer : (15/30/45/60/75/90/120/180 min)
- Operating status LED

Specifications

- Rated voltage : 220-240V ~
- Power : 560 W
- Product dimensions (WxDxH) : 16 x 14 x 36 cm
- Product weight : 1,8 kg
- Number of hose : 1
- Attachment for shoes





Quilt Dryer Twin Nozzle FK-W1



+

- 4 preset modes (Winter, Summer, Warm, Dust mites)
- Powerful heat (65°)
- Extendable hose
- OFF timer
- Multi usage (Bed, Shoes)

Functions

- Preset mode
 - 4 modes : Winter (65° C for 60 min), Summer (65° C for 60 min), Warm Up (65° C for 20 min), Dust Mite (65° C for 100 min)
- Manual mode
 - 3 modes : High (65° C), Low (50° C), Fan
- OFF timer : Yes (15/30/45/60/75/90/120/180 min)
- Operating status LED

Specifications

- Rated voltage : 220-240V ~
- Power : 700 W
- Product dimensions (WxDxH) : 16,8 x 19,5 x 36 cm
- Product weight : 2,2 kg
- Number of hose : 2
- Attachment for shoes







COOKING



Multi Cooker PC-MA3



Easy to use



6 Preset programmes & 6 manual cooking modes



Keep warm function

Functions

- 6 Preset programmes : Rice, Stew, Roast, Bean, Soup, Cake
- 6 Manual modes : Pressure, Temperature cook, Slow cook, Hot pot, Steam, Heat up
- Including accessories : Measuring cup, Steam rack

Specifications

- Rated voltage : 220-240V ~
- Rated power : 800 W
- Maximum pressure : 70 kPa
- Inner pot capacity : 3 L
- Product dimensions (WxDxH) : 30 x 28,8 x 22,4 cm
- Product weight : 3,9 kg





IH rice cooker RC-ID31



- +**
-  2 in 1 : Rice cooker + Induction cooktop
 -  Rice texture setting
 -  Copper coating 5-layer inner pot
 -  Keep warm function

Functions (Rice cooker)

- 3 rice texture : Soft, Regular, Firm
- 8 menus : White, Rinse free, Quick, Mixed, Sushi rice, Porridge/Soup, Stew

Functions (Induction cooktop)

- 5 heat level
- Energy efficient

Specifications

- Rated voltage : 220-240V ~
- Rated wattage (rice cooker) : 800 W
- Rated wattage (induction cooktop) : 1000 W
- Max rice cooking capacity : 0,54 L (3 cups)
- Including accessories : 2 measuring cups, spatula
- Product dimensions (WxDxH) : 22,5 x 28 x 22 cm
- Product weight : 4,4 kg











OFFERS



Heated Vest Men HW-01M & Women HW-01W



-  Carbon nanotube technology
-  Lightweight & Comfortable
-  Quick heat-up
-  Hand washable

Specifications

- Heating Technology : Carbon Nanotube
- Heating Level : 1-4
- Outer Fabric Material : Polyester
- Filling Material : Polyester
- Size : S/M/L
- Cable input port : USB Type-A
- Including Accessories : Storage bag
- Battery is not included





Ceiling Light Dim

Ceiling Light Dim&Ton



Remote control for
Ceiling Light Dim range



Remote control for
Ceiling Light Dim&Ton range



10 brightness
adjustment



Long lasting



Night mode

Specifications

- Rated power :
 - CL6D-5.0G : 30 W
 - CL8D-5.0G : 35 W
 - CL12D-5.0G : 40 W
 - CL14D-5.0G : 45 W
- Rated voltage : 220-240V ~
- Lumen :
 - CL6D-5.0G : 3500 LM
 - CL8D-5.0G : 4000 LM
 - CL12D-5.0G : 5000 LM
 - CL14D-5.0G : 5500 LM
- Dimming levels : 10
- Dimensions : $\Phi 45 \times 9,3$ cm
- Weight : 1,2 kg
- OFF timer
- Remote control

Specifications

- Rated Power :
 - CL6DL-5.0G : 30 W
 - CL8DL-5.0G : 35 W
 - CL12DL-5.0G : 40 W
 - CL14DL-5.0G : 45 W
- Rated voltage : 220-240V ~
- Lumen :
 - CL6DL-5.0G : 3500 LM
 - CL8DL-5.0G : 4000 LM
 - CL12DL-5.0G : 5000 LM
 - CL14DL-5.0G : 5500 LM
- Dimming levels : 10
- Tuneable colour : 11 colours temperature
- Dimensions : $\Phi 45 \times 9,3$ cm
- Weight : 1,2 kg
- OFF timer
- Remote control



Brightness adjustment



Color temperature adjustment



White hot

Cool/pure white



Dry Cell Battery LR6/AA

Dry Cell Battery LR03/AAA



Long lasting



10- year shelf life

Specifications (LR6/AA/20)

- Dimensions : 14 x 2,8 x 4,8 cm
- Weight : 491 g
- Battery type : Alkaline
- Voltage : 1,5 V
- Size : AA
- Number of batteries : 20

Specifications (LR6/AA/48)

- Dimensions : 12 x 9 x 5,7 cm
- Weight : 1,2 kg
- Battery type : Alkaline
- Voltage : 1,5 V
- Size : AA
- Number of batteries : 48

Specifications (LR6/AA/100)

- Dimensions : 14,8 x 14,8 x 5,7 cm
- Weight : 2,5 kg
- Battery type : Alkaline
- Voltage : 1,5 V
- Size : AA
- Number of batteries : 100

Specifications (LR03/AAA/20)

- Dimensions : 10,3 x 2,2 x 4,3 cm
- Weight : 237 g
- Battery type : Alkaline
- Voltage : 1,5 V
- Size : AAA
- Number of batteries : 20

Specifications (LR03/AAA/48)

- Dimensions : 9 x 6,8 x 5,2 cm
- Weight : 583 g
- Battery type : Alkaline
- Voltage : 1,5 V
- Size : AAA
- Number of batteries : 48

Specifications (LR03/AAA/100)

- Dimensions : 11 x 11 x 5,2 cm
- Weight : 1,2 kg
- Battery type : Alkaline
- Voltage : 1,5 V
- Size : AAA
- Number of batteries : 100

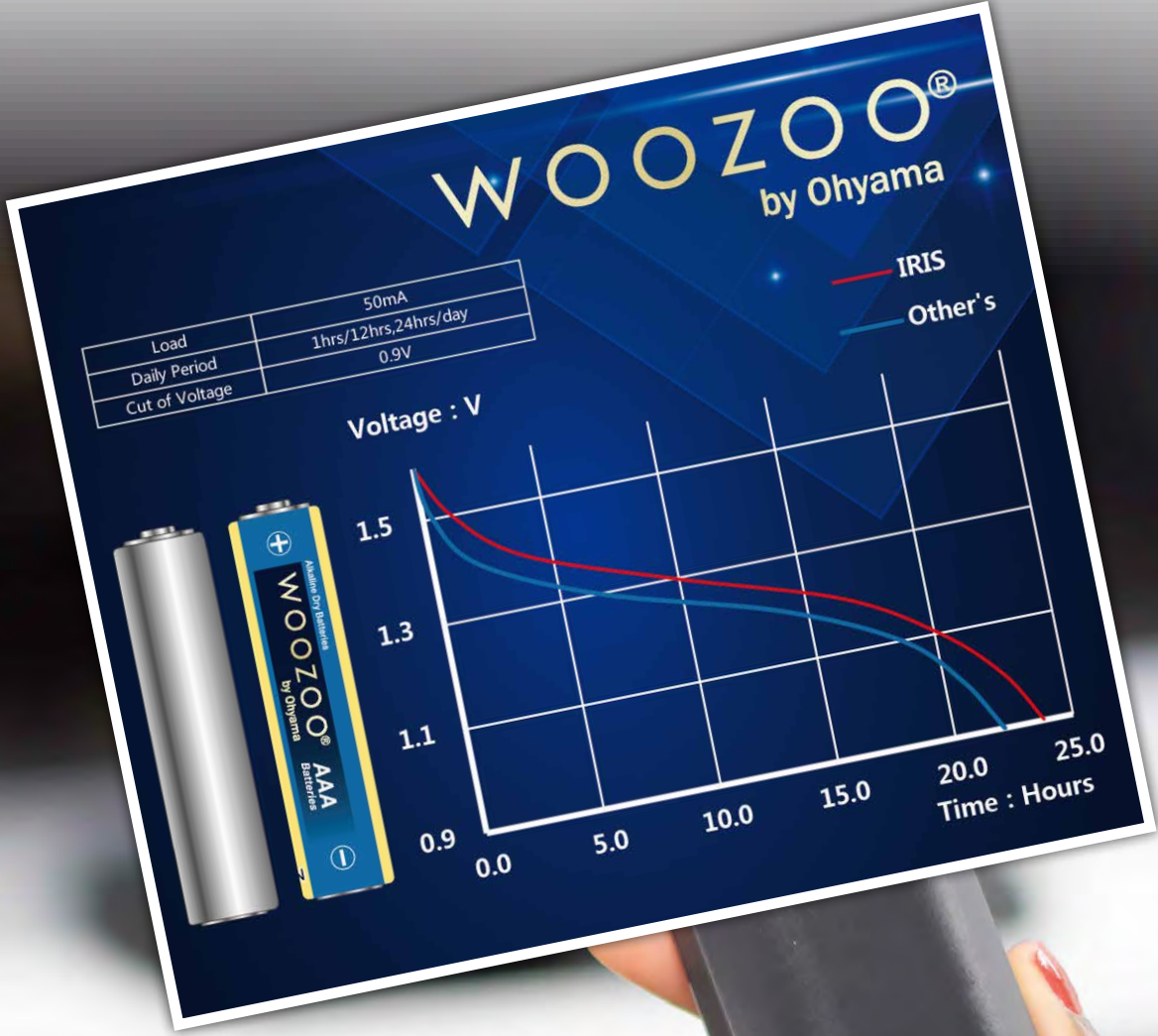

WOZOO®

by Ohyama

IRIS OHYAMA FRANCE



990 Avenue Marguerite Perey,
77127 Lieusaint,
France



+33 1 60 60 58 58



adv.lieusaint@iriseurope.fr

IRIS OHYAMA EUROPE



Gesworenhoeckseweg 1,
5047 TM, Tilburg,
The Netherlands



+31 13 578 0022



info@iriseurope.com



www.irisohyama.fr

